

# TAKSTAR® 得胜



## HM-500W

手持麦克风

Handheld Microphone

使用手册 | User Manual

## ■ 前言

尊敬的用户：

感谢您选购得胜 HM-500W 手持麦克风，为了您能够更好地了解使用本产品，建议您在使用前仔细阅读本说明书。

若存在有疑问或者您有宝贵的建议，可通过拨打得胜官方服务热线 400 6828 333 或微信扫描二维码关注得胜官方公众号与我们联系。



## ■ 产品特性

- 一麦两用的手持麦克风，支持无线手持麦克风扩声，又能当翻页笔使用；
- 采用 2.4G 无线传输技术，麦克风室内无线使用距离达 20 米；
- 采用无线数字技术，抑制啸叫和杂音，还原高保真音质；
- 内置高性能锂离子电池，续航持久；
- 翻页笔支持音量控制、翻页、全屏、播放幻灯片等功能操作；
- 一体式设计，迷你接收器内嵌吸附于尾部，收纳方便防丢失；
- 产品采用全新外观设计，造型新颖，外观时尚，使用轻巧便捷。

## ■ 适用范围

适用教学、培训、宣讲活动与扩音器搭配使用

## ■ 标准配置

手持麦克风.....	1支
接收器.....	1个
Type-C充电线.....	1条
3.5mm转6.35mm转接头.....	1个
说明书.....	1份

## ■ 技术参数

### 手持麦克风参数

- 拾音器：背极式驻极体
- 指向性：单指向
- 频率响应：60Hz-16kHz
- 灵敏度：-45 至 -46dB
- 使用距离：室内约 20 米
- 电池类型：锂离子电池
- 电池容量：3.7V/400mAh
- 充电规格：5V=1A
- 充电时间：约 1 小时
- 使用时间：约 10 小时
- 净重：约 39g
- 激光类型：3R 类激光
- 激光距离：>50 米
- 激光功率：<5mW
- 接口：USB3.0/2.0/1.1
- 工作电压：3.7V
- 操作系统：Windows / Android / Mac OS / Linux

### 接收器参数

- 遥控方式：2.4GHz
- 使用距离：约20米(室内)
- 电池类型：锂离子电池
- 电池容量：3.7V/300mAh
- 充电规格：5V=1A
- 充电时间：约1小时
- 使用时间：约9小时
- 单机重量：约15g

注：以上数据由得胜实验室测试得到，并拥有最终解释权！

## ■ 功能示意

### 手持麦克风

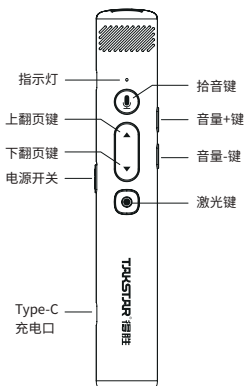

- ① 电源开关: 拨至“ON”开机, 拨至“OFF”关机。
- ② 音量+键: 点按增加音量, 共8级音量可调节。
- ③ 音量-键: 点按减小音量, 共8级音量可调节。
- ④ 拾音键: 点按开启/关闭麦克风拾音; 未连接绿灯闪烁, 连接成功时绿灯常亮。
- ⑤ 下翻页键: 单击下翻页; 长按全屏播放/退出全屏 (播放PPT时)。
- ⑥ 上翻页键: 单击上翻页; 长按黑屏/退出黑屏 (播放PPT时)。
- ⑦ 激光键: 长按打开激光, 松开关闭激光。
- ⑧ Type-C充电口: 连接Type-C充电线给麦克风充电。
- ⑨ 指示灯: 电量充足时, 绿灯常亮; 低电量, 红灯闪烁; 充电时, 红灯常亮; 充满电, 红灯熄灭。

注: 麦克风在连接或未连接的状态下, 20分钟无拾音自动关机。

## 接收器

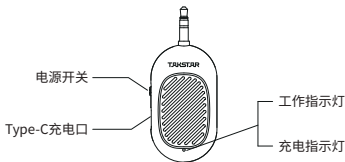

- ① 电源开关:拨至“ON”开机;拨至“OFF”关机。
- ② 工作指示灯:未配对时,绿灯闪烁;配对成功,绿灯常亮。
- ③ 充电指示灯:低电量,红灯闪烁;充电时,红灯常亮;充满电,红灯熄灭。
- ④ Type-C充电口:连接Type-C充电线进行充电。

注:自动关机:接收器在连接或未连接的状态下,20分钟无拾音自动关机。

## ■ 使用说明

### 一、配对方法

1. 打开手持麦克风和接收器的电源开关;
2. 点按手持麦克风的拾音键,待接收器及手持麦克风的工作指示灯由闪烁变为常亮,表示配对成功;
3. 将接收器的插头接到扩音器的MIC输入接口,即可进行扩音使用。
4. 打开手持麦克风及接收器电源开关,将自动配对连接,待接收器指示灯从闪烁状态变为常亮且点按拾音键后对着麦克风说话,扩音器有声音输出,表示配对成功,如遇信号干扰,可按下面方法重新配对:
  - ① 同时长按手持麦克风音量“+”“-”键2秒进入配对搜索状态,待接收器指示灯从闪烁状态变为常亮且点按拾音键后对着麦克风说话,扩音器有声音输出,表示配对成功。
  - ② 如对着麦克风说话扩音器没声音,表示配对不成功,请按上面方法重新配对。

## 二、翻页功能使用

1. 将USB接收器从手持麦克风的尾部取出。

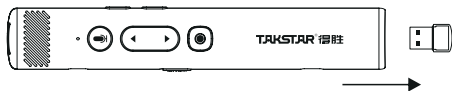

2. 插入电脑的USB接口。

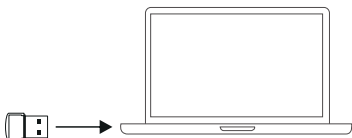

## ■ 安全警示

为避免电击、高温、着火、辐射、爆炸、机械危险以及使用不当等可能造成的人身伤害或财产损失,使用本产品前,请仔细阅读并遵守以下事项:

1. 使用产品时请确认所连设备与本产品是否匹配以及合理调整音量大小,不要在超过产品功率及大音量下长时间使用,以免造成产品异常;
2. 使用中若发现有异常(如冒烟、异味等),请立即关闭电源开关并拔掉电源插头,然后将产品送售后服务网点检修;
3. 消费者若使用电源适配器供电,则应购买配套使用获得CCC认证并满足标准要求的电源适配器;
4. 本产品及附件都应放置在室内干燥通风处,请勿长期存放在潮湿、灰尘多的环境,使用中避免靠近火源、雨淋、进水、过度碰撞、抛掷、振动本机及覆盖通风孔,以免损坏其功能;
5. 若产品需要固定于墙壁或天花板时,请确保固定到位,防止因固定强度不足导致产品发生跌落危险;
6. 使用该产品时需遵守相关安全规定,法律法规明确禁止使用场合请勿使用本产品,以免导致意外事故;
7. 请不要自行拆机改装或维修,以防止出现人身伤害,如有问题或服务需求请联系当地售后服务网点跟进处理。

## ■ 关于图标含义解释



此符号表示, 根据WEEE指令(2012/19/EU)和国家法律, 由于这种类型的废弃物会有潜在的有害物质, 可能对环境 and 人类健康产生负面影响, 所以

本产品不应与您的家庭垃圾一起处置, 应将本产品交由授权的电气和电子设备 (WEEE) 回收站回收。同时, 您在正确处理本产品的同时将有助于自然资源的有效利用。如需了解更多有关您可以在何处放置废物回收设备的信息, 请联系您当地的城市办事处、废物管理局或家庭废物处理服务部门。

## ■ 关于本说明书

本说明书中内容符合截止印刷之日的技术规格。由于得胜公司会不断改进产品, 本说明书可能不符合您的特定产品的技术规格。要获取最新版说明书, 请访问得胜官网, 然后下载说明书文件。技术规格、设备或另售的附件在各个地区可能有所不同, 如有问题请与当地得胜销售网点确认。如需更多支持和深层产品信息, 请浏览得胜官方网站: <https://www.takstar.com>

版权所有 ©2025 得胜。得胜、TAKSTAR及其各自标志是得胜公司在中国和/或其他国家/地区的注册商标或商标。所有其它商标均是其各自所有者的财产。

## ■ 环保说明

产品中有毒有害物质或元素的名称及含量标识表

部件名称	有毒有害物质或元素									
	铅 (Pb)	汞 (Hg)	镉 (Cd)	六价铬 (Cr(VI))	多溴联苯 (PBB)	多溴二苯醚 (PBDE)	邻苯二甲酸二正丁酯 (DBP)	邻苯二甲酸二异丁酯 (DIBP)	邻苯二甲酸丁基苯酯 (BBP)	邻苯二甲酸二(2-乙基)己酯 (DEHP)
塑料部件	○	○	○	○	○	○	○	○	○	○
金属部件	×	○	○	○	○	○	○	○	○	○
电路板组件	×	○	○	○	○	○	○	○	○	○
线缆	×	○	○	○	○	○	○	○	○	○

本表格依据SJ/T 11364的规定编制。

○: 表示该有害物质在该部件所有均质材料中的含量均在 GB/T 26572 规定的限量要求以下。

×: 表示该有害物质至少在该部件的某一均质材料中的含量超出 GB/T 26572 规定的限量要求。

此标志为产品的环保使用期限标志,

且此环保使用期限只适用于产品正常工作的温度和湿度等条件。



## ■ Preface

Dear Customer,

Thank you for purchasing Takstar HM-500W Handheld Microphone. In order to better understand and use the product, please read this manual carefully.

If you have any questions or suggestions, please contact our local dealer.

## ■ Features

- Dual-function handheld microphone: supports wireless sound amplification and works as a presentation clicker.
- Adopts 2.4G wireless transmission technology, with the microphone's indoor wireless working distance up to 20 meters.
- Utilizes wireless digital technology to suppress feedback and noise, restoring high-fidelity sound quality.
- Built-in high-performance lithium-ion battery offers long-lasting battery life.
- The presentation clicker supports functions such as volume control, page turning, full-screen display and slide playback.
- All-in-one design with mini receiver that magnetically snaps into the tail compartment, enabling convenient storage and loss prevention.
- The product features an all-new exterior design with innovative contours, fashionable aesthetics, and lightweight portability for effortless usability.

## ■ Applications

Suitable for teaching, training, and presentation events, when used with amplifiers.

## ■ Package Contents

- |                           |                             |
|---------------------------|-----------------------------|
| 1 × Handheld Microphone   | 1 × Receiver                |
| 1 × Type-C Charging Cable | 1 × 3.5mm to 6.35mm Adapter |
| 1 × User Manual           |                             |

## ■ Specifications

### Handheld Microphone

- Transducer: Back-electret condenser
- Polar Pattern: Uni-directional
- Frequency Response: 60Hz-16kHz
- Sensitivity: -45 to -46dB
- Operating Distance: Approx. 20m (Indoor)
- Battery Type: Lithium-ion battery
- Battery Capacity: 3.7V/400mAh
- Charging Specification: 5V=1A
- Charging Time: Approx. 1 hour
- Operating Time: Approx. 10 hours
- Net Weight: Approx. 39g
- Laser Type: Class 3R laser
- Laser Distance: >50m
- Laser Power: <5mW
- Interface: USB3.0/2.0/1.1
- Operating Voltage: 3.7V
- Operating System: Windows/Android/Mac OS/Linux

### Receiver

- Remote Control: 2.4GHz
- Operating Distance: Approx. 20m (Indoor)
- Battery Type: Lithium-ion battery
- Battery Capacity: 3.7V/300mAh
- Charging Specification: 5V=1A
- Charging Time: Approx. 1 hour
- Operating Time: Approx. 9 hours
- Unit Weight: Approx. 15g

Note: The above data are measured by Takstar laboratory which has the final interpretation right!

## ■ Function Descriptions

### Handheld Microphone

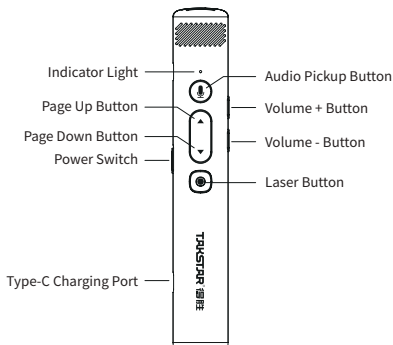

- ① Power Switch: Toggle to "ON" to power on, toggle to "OFF" to power off.
- ② Volume + Button: Press briefly to increase volume; there are 8 adjustable volume levels.
- ③ Volume - Button: Press briefly to decrease volume; there are 8 adjustable volume levels.
- ④ Audio Pickup Button: Press to enable/disable microphone audio pickup. Green light flashes when not connected, and stays on when connected.
- ⑤ Page Down Button: Single press to page down; long press to enter/exit full-screen mode (during PPT playback).
- ⑥ Page Up Button: Single press to page up; long press to turn the screen black/restore the screen (during PPT playback).
- ⑦ Laser Button: Long press to activate the laser; release to deactivate it.
- ⑧ Type-C Charging Port: Connect a Type-C charging cable to charge the microphone.
- ⑨ Indicator Light: Green light stays steady when battery is full, red light flashes when battery is low, red light stays steady during charging, and red light turns off when fully charged.

Note: The microphone will automatically turn off after 20 minutes of no audio pickup, whether connected or not.

## Receiver

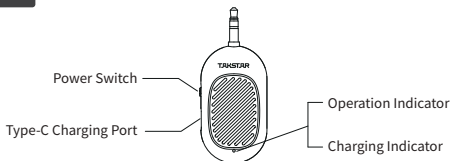

- ① **Power Switch:** Toggle to "ON" to power on; toggle to "OFF" to power off.
- ② **Operation Indicator:** Green light flashes when unpaired; green light stays on when paired successfully.
- ③ **Charging Indicator:** Red light flashes when battery is low; red light stays on when charging; red light turns off when fully charged.
- ④ **Type-C Charging Port:** Connect a Type-C charging cable to charge the receiver.

**Note:** Auto Power-Off: The receiver will automatically turn off after 20 minutes of no audio pickup, whether connected or not.

## ■ Operating Instructions

### I. Pairing Method

1. Turn on the power switches of the handheld microphone and the receiver.
2. Press the audio pickup button of the handheld microphone. When the operation indicators of both the receiver and the handheld microphone change from flashing to steady on, it indicates successful pairing.
3. Connect the plug of the receiver to the MIC input jack of the amplifier to use it for sound amplification.
4. Turn on the power switches of the handheld microphone and receiver; they will pair and connect automatically. Pairing is successful when the receiver's indicator light changes from flashing to steady, and the amplifier outputs sound when you press the audio pickup button and speak into the microphone. In case of signal interference, re-pair using the following method:
  - ① Press and hold the volume "+" and "-" buttons on the handheld microphone simultaneously for 2s to enter pairing search mode. Once the receiver's indicator light changes from flashing to steady, press the audio

pickup button, then speak into the microphone—pairing is successful if the amplifier outputs sound.

- ② If the amplifier has no sound when you speak into the microphone, pairing has failed; please re-pair using the above method.

### II. Usage of Page-Turning Function

1. Remove the USB receiver from the tail of the handheld microphone.

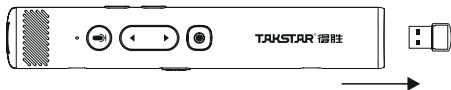

2. Insert it into the USB port of the computer.

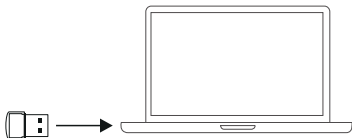

### ■ Safety Instructions

To avoid electric shock, overheat, fire, radiation, explosion, mechanical risk and injury or property loss due to improper use, please read and observe the following items before use:

1. Please check if the power of the connected equipment matches with that of this product before operation. Adjust the volume to proper level during operation. Do not operate at over-power or high-volume level for extended time to avoid product malfunction.
2. If there is any abnormality during use (e.g., smoke, strange odor), please kill the power switch and unplug from power source, then send the product to the local after-sales service for repair.
3. Power adapter used, if any, should be approved by CCC certification or similar standards and comply with the power supply requirements.
4. Keep this product and its accessories in a dry and ventilated area. Do not store in a humid or dusty area for extended time. Keep away from fire, rain,

liquid intrusion, bumping, throwing, vibrating, or from blocking any ventilation openings, to prevent malfunction.

5. The product must, when installed on walls or ceilings, be fixed firmly in place at adequate strength to prevent from falling.
6. Please abide by safety rules during operation. Do not use the product in places prohibited by laws or regulations to avoid accident.
7. Do not disassemble or repair the product unauthorized to avoid injury. If you have any questions or require any services, please contact our local after-sales service.

### ■ Label Meanings



This symbol indicates that this product should not be disposed of with your household waste, according to the WEEE directive (2012/19/EU) and your national law. This product should be  handed over to an authorized collection site for recycling waste electrical and electronic equipment (WEEE). Improper handling of this type of waste could have a possible negative impact on the environment and human health due to potentially hazardous substances that are generally associated with WEEE. At the same time, your cooperation in the correct disposal of this product will contribute to the effective usage of natural resources. For more information about where you can drop off your waste equipment for recycling, please contact your local city office, waste authority, or your household waste disposal service.

### ■ About This Manual

This manual contains up-to-date technical specifications as of printing. However, specifications contained herein may not conform to your particular product since Takstar is constantly improving its products. Also, specifications, devices or accessories available may vary from region to region. If you have any questions, please contact our local sales outlet. For the latest version/more information, please visit our website:

<https://www.takstar.com/>

Copyright ©2025 TAKSTAR. TAKSTAR, 得胜 and their respective logos are registered trademarks or trademarks of Takstar company in the PRC, and/or other countries. All other trademarks are the property of their respective owners.

## 注意事项:

1. 本单为保修凭证, 请用户妥善保管, 如有遗失, 恕不保修或退换。
2. 保修期限制: 购买之日起十二个月内。
3. 除了不可抗力事件损坏外, 由本公司负责, 免费维修。
4. 如属保管不善或使用不当造成的损坏, 维修点将酌情收费。
5. 擅自拆卸维修者, 不予保修。
6. 以上保修条款仅限于中国市场适用 (不含港澳台地区)。

# 产品服务保证书

姓名: \_\_\_\_\_ 电话: \_\_\_\_\_ 地址: \_\_\_\_\_

商品: \_\_\_\_\_ 型号: \_\_\_\_\_ 购买日期: \_\_\_\_\_ 年 \_\_ 月 \_\_ 日

维修记录栏 (由维修员填写)	维修员签名	日期

◆ 广东得胜电子有限公司 ◆ 电话: 400-6828-333 ◆ 地址: 广东省惠州市博罗县龙溪街道富康一路2号

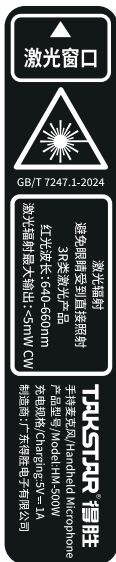

此警示标贴贴于产品背面  
This warning label is affixed to product rear.

**注意:**

1. 若不按规定使用控制或调整装置、或执行各步操作,就可能引起有害的辐射照射;
2. 本激光产品的激光安全等级符合标准GB/T 7247.1-2024;
3. 所提供的激光孔径发射的激光辐射水平超过1级;
4. 光束发散角1.8mrad。

**Caution:**

1. Hazardous radiation exposure may occur if controls or adjustments are operated incorrectly.
2. This laser product's safety class complies with GB/T 7247.1-2024.
3. Laser radiation from the provided aperture exceeds Class 1.
4. Beam divergence angle: 1.8mrad.



扫一扫，了解更多产品  
Scan for more  
product information

## **广东省电声工程技术研究开发中心 广东得胜电子有限公司制造**

地址：广东省惠州市博罗县龙溪街道富康一路2号

服务热线：400 6828 333 传真：0752 6383950

邮箱：xs@takstar.com

网址：www.takstar.com

Guangdong Takstar Electronic Co., Ltd.

Address: No. 2 Fu Kang Yi Rd., Longxi Boluo

Huizhou, Guangdong 516121 China

Tel: 86 752 6383644 Fax: 86 752 6383952

Email: sales@takstar.com

Website: www.takstar.com